

---

# Electric Hob

LAM1210

LAM1211

LAM1213



User & Installation Guide

---

**LAMONA**

Exclusive to Howdens Joinery Co.

---

Dear Customer,  
Congratulations on your choice of hob which has been designed to give you excellent service.

**The user manual will help you use your product quickly and safely.**

- Please read this user manual before installing and using the hob.
- Always follow the safety instructions.
- Keep this user manual within easy reach for future reference.
- Please read any other documents supplied with the product.

Explanation of symbols

Throughout this user manual the following symbols are used:



Important information or useful tips about usage.



Warning for possible hazards to health and property



Warning possibility of electric shock.



This product's packaging material is recyclable. Help recycle it and protect the environment by dropping it off in the municipal receptacles provided for this purpose. Your product also contains a great amount of recyclable material. It is marked with this label to indicate the used appliances that should not be mixed with other waste. This way, the appliance recycling organised by your manufacturer will be done under the best possible conditions, in compliance with European Directive 2002/96/EC on Waste Electrical and Electronic Equipment. Contact your town hall or your retailer for the used appliance collection points closest to your home. We thank you doing your part to protect the environment.

**EN Important instructions and warnings for safety and environment**

- This appliance can be used by children aged from 8 years and above and persons with reduced physical, sensory or mental capabilities or lack of experience and knowledge if they have been given supervision or instruction concerning use of the appliance in a safe way and understand the hazards involved.

Children shall not play with the appliance. Cleaning and user maintenance shall not be made by children without supervision.

- The appliance and its accessible parts become hot during use. Care should be taken to avoid touching heating elements. Children less than 8 years of age shall be kept away unless continuously supervised.
- Do not use steam cleaners to clean the appliance as this may cause an electric shock.
- Only use the connection cable specified in the "Technical specifications".
- If the power connection cable for the product is damaged, it must be replaced by the manufacturer, its service agent or similiary qualified persons in order to avoid a hazard.
- The appliance must be installed so that it can be completely disconnected from the network. The separation must be provided either by a mains plug, or a switch built into the fixed electrical installation, according to construction regulations.

- Unattended cooking on a hob with fat or oil can be dangerous and may result in fire. NEVER try to extinguish a fire with water, but switch off the appliance and then cover flame e.g. with a lid or a fire blanket.
- Danger of fire: Do not store items on the cooking surfaces.
- The appliance is not intended to be operated by means of an external timer or separate remote-control system.
- Glass surface models: If the surface is cracked, switch off the appliance to avoid the possibility of electric shock.
- Induction models: Metallic objects such as knives, forks, spoons and lids should not be placed on the hob surface since they can get hot.
- With top lid models: Do not close the top cover before the hotplates or burners cool down. Wipe the top cover dry before opening it in order to avoid water leakage to the rear and inner sections of the oven.

---

# Index

<b>01 - Before Using the hob</b>	<b>06</b>
<b>02 - Safety</b>	<b>06</b>
General	06
Fire safety advice	07
If a pan catches fire	07
Deep fat frying	07
If you have an Electrical Fire	07
<b>03 - Using your hob</b>	<b>08</b>
Controls	08
Heat Settings	08
Hob Layout	09
<b>04 - Cleaning and Maintenance</b>	<b>10</b>
How to clean your hob	10
<b>05 - Installation</b>	<b>10</b>
General Information	10
Positioning	10
Protecting the hob cut out	10
Clearances and dimensions requirements	11
Connect to the electricity supply	12
Technical Data	13
<b>06 - Your Guarantee</b>	<b>14</b>

## 01 - Before using the hob

- Make sure that you have removed all packaging, wrappings, stickers and films from the hob surface.
- It is recommended that you clean and wash the hob surface before using for the first time.
- Before using the hob for the first time switch the hotplates on to full power for five minutes, without placing any pans on top. Do not switch more than one hotplate on at a time. At this point it is normal to notice smoke and odours, but these will disappear over time.

## 02 - Safety



This appliance is for domestic cooking purposes only. It must not be used for other purposes, for example room heating.

### General



Accessible parts may become hot during use. To avoid burns, children less than 8 years of age should be kept away unless continuously supervised.

This appliance can be used by children aged 8 years and above, persons with reduced physical, sensory or mental capabilities or lack of experience and knowledge if they have been given supervision or instruction concerning use of the appliance in a safe way and understand the hazards involved. Children must not play with the appliance. Cleaning and user maintenance must not be made by children without supervision.



Servicing should be carried out only by authorised personnel.

**Do not** spray aerosols in the vicinity of this appliance while it is in operation.

**Do not** store or use flammable liquids or items in the vicinity of this appliance.

**Do not** modify this appliance.

- **Always** ensure that pan bases are dry and flat before using them on the hob.
- **Always** position pans over the centre of the heat zone, and turn the handles to a safe position so they cannot be knocked over or grabbed by children.
- **Always** use pans which are no smaller than 100mm (4") or no larger than 250mm (10")
- **Always** match the size of pan to the heat zone do not use large pans on small zones or vice versa.
- **Always** lift pans onto and off the hob, rather than sliding them across the surface to avoid marks and scratches.
- **Never** use double pans, rim-based pans, old or misshapen pans, or any pan that is not stable on a flat surface.
- **Never** leave cooking fat, or oil, unattended.
- **Never** use commercial simmering aids, or heat diffusers, as they create excessive heat and can damage the surface of the hob.
- **Never** use the hob for any other purpose than cooking food.
- **Never** leave plastic utensils close to, or on top of the hob -they could melt!
- **Never** leave any cook zone on without a pan covering it. This causes potential a fire hazard.

- **Never** use the hob surface as a chopping board or food preparation area, as this may lead to it becoming damaged.
- **Never** put metal cooking utensils, cutlery, knives or other metal objects on the hob. They could become hot if they are near a cooking area which is in use.
- **Never** leave aluminium foil on the hob top, it reflects heat back into the element which leads to damage.
- **Never** heat up a sealed tin of food on the hob, as it may explode.
- **Never** leave pans overhanging the edge of the hob.

## Fire safety advice

---

- Most kitchen fires occur when people are distracted or leave things unattended, so remember:
- If you're called away from the hob - by the phone or someone at the door, either take pans off the heat, or switch off your hob.
- Don't let yourself be distracted while cooking.
- If you do have a fire in the kitchen, don't take any risks - get everyone out of your home and call the Fire Service

## If a pan catches fire:

---

- Do not move it as it's likely to be extremely hot.
- Turn off the heat if it's safe to do so, but never lean over a pan to reach the controls.
- Use fire blanket or a damp tea-towel to cover the pan.
- If you have put the fire out, leave the pan to cool completely.

## Deep-fat frying presents more dangers in your kitchen

---

- Never fill a chip pan (or other deep fat fryer) more than one-third full of oil.
- Do not use a fire extinguisher on a pan of burning oil - the force of the extinguisher can spread the fire and create a fireball.

## If you have an electrical fire in the kitchen:

---

- Pull the plug out, or switch off the power at the fuse box - this may be enough to stop the fire immediately
- Smother the fire with a fire blanket, or use a dry powder or carbon dioxide extinguisher
- Remember: never use water on an electrical or cooking oil fire.

## 03 - Using the hob - Electric Hob



Do not use the hob if the surface is cracked, as electrical parts are directly beneath. Switch off the appliance at the supply to prevent electric shock and contact your supplier.



The hob surface remains hot after use. DO NOT TOUCH.





The appliance is not intended to be operated by means of an external timer or separate control system.

### Controls

Rotate in either direction to switch on and select the heat level. Each zone has 6 fixed heat settings as described in the heat settings table.

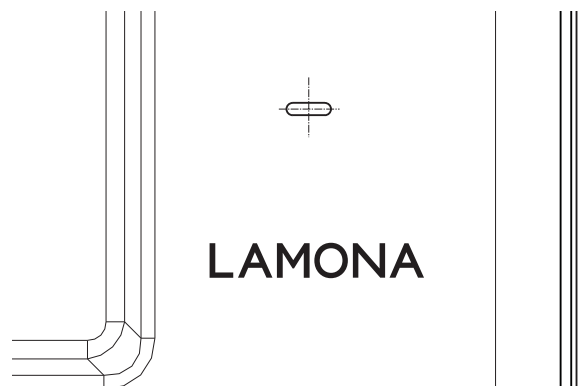
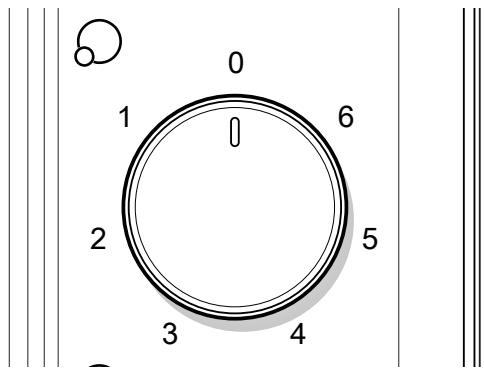
When any one of the heating zones is on, the red indicator light on the control panel lights up.



To switch a heating zone off turn the corresponding knob to  (zero)

### Heat settings

Heat Settings		
1	2 - 3	4 - 5 - 6
Warming	Simmering & Stewing	Frying & Boiling



## Hob layout

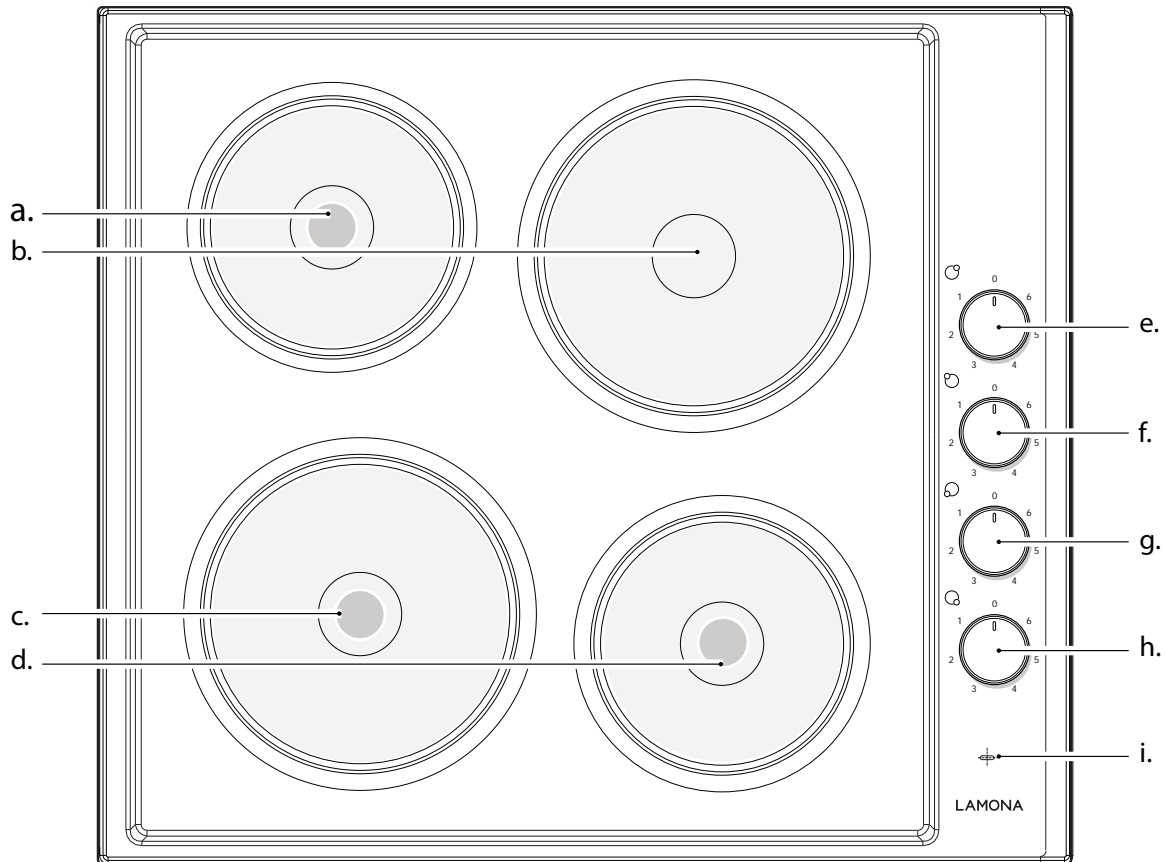

- |    |   |    |                          |
|----|---|----|--------------------------|
| a. | <b>Rear Left Zone (Rapid) Ø145mm 1500w</b><br>Suitable for 6" or 15cm diameter saucepan     | e. | Rear right control Knob  |
| b. | <b>Rear Right Zone (Standard) Ø180mm 1500w</b><br>Suitable for 7" or 18cm diameter saucepan | f. | Rear left control Knob   |
| c. | <b>Front Left Zone (Rapid) Ø180mm 2000w</b><br>Suitable for 7" or 18cm diameter saucepan    | g. | Front left control Knob  |
| d. | <b>Front Right Zone (Rapid) Ø145mm 1500w</b><br>Suitable for 6" or 15cm diameter saucepan   | h. | Front right control Knob |
|    |   | i. | Hob on Indicator.        |

## 04 - Cleaning & maintenance

### How to clean your hob

---

- Switch plates off and let cool. If necessary, treat plates with a cleaning agent (cleaner/conditioner available in selected stores).
- Dry by switching on for a few minutes.
- The hob can be cleaned using a clean damp cloth or kitchen paper. Do not use a dish cloth or sponge as these can leave a film of detergent on the surface which can lead to discolouration.
- Apply a thin coat of cooking oil from time to time to provide a protective coating.
- Do not use steam cleaners or high pressure cleaning equipment.
- Wipe any spillage as soon as possible after the hob has cooled.
- Clean the hob top as regularly as possible, this will prevent any build up of grease which may be a fire hazard.
- Do not use abrasive products, bleach, hob cleaner spray or pan scourers.

## 05 - Installation

### General information

---

Installation should only be carried out by a qualified installer or engineer.



Please Note:

Although every care has been taken to ensure this appliance has no burrs, or sharp edges, We recommend that you wear protective gloves when installing and moving this appliance. This will prevent injury.

The hob should not be fitted above a washing machine, a fridge or a freezer. Wall surfaces above the work surface and in the immediate vicinity of the cooking hob must be heat resistant.

Laminated surfaces and the adhesive used for fixing them must be heat resistant in order to avoid any damage.

Installations should be carried out in line with the National Regulations applicable with this product type.

### Positioning

---

The hob is designed to be built into a work top as detailed in the image.

Aperture width 560mm x depth 490mm

### Protecting the Hob cut-out

---

The types of chipboard used for work surfaces swell relatively quickly in contact with humidity.

Apply a special varnish or adhesive to the cut edge to protect it from moisture ingress.

## Clearances and dimensions requirements

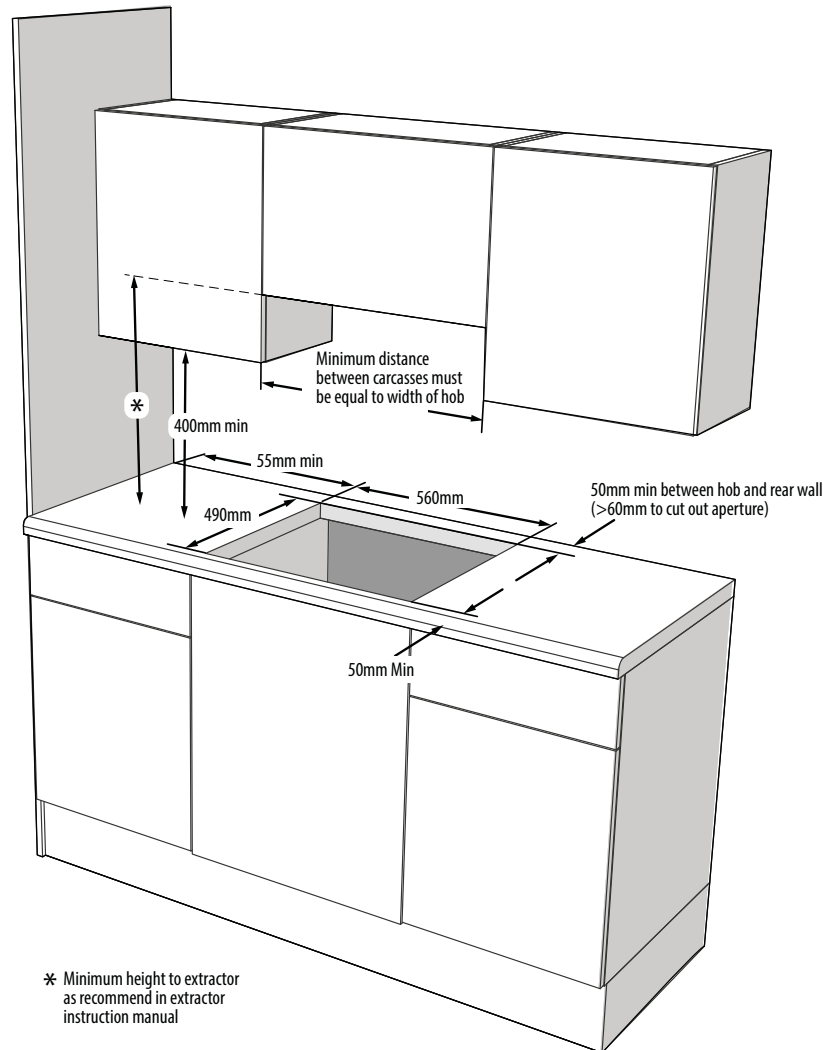

No shelf or overhang of combustible material should be closer than 650mm directly above the hob.

There must be a minimum clearance of 50mm between the rear edge of the hob and the rear wall. This clearance must be maintained up to 650mm above the worktop (unless otherwise stated in your extractor manual).



**Apply a thin bead of the putty seal (provided) to the underside of the hob.**

For best results ensure the putty is applied evenly, as close to the edge as possible and only use the necessary amount. Once in position, trim any excess putty away with a blunt knife taking care not to damage the worktop.

Place the hob in the aperture, checking the hob is covering the worktop along all four sides. Set the front edge of the appliance parallel with the front of the worktop.

Secure the hob to the worktop by means of the brackets provided, taking the thickness of the worktop into account. Your appliance will be supplied and installed using the following installation method.

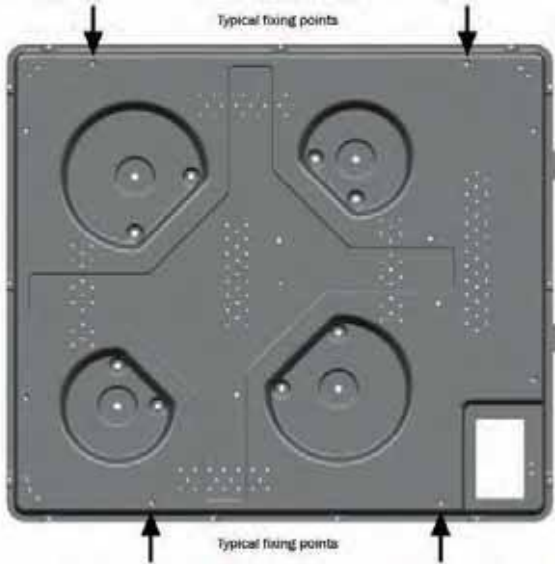

**Method 1**

The brackets screw directly into the base of the hob in the positions shown

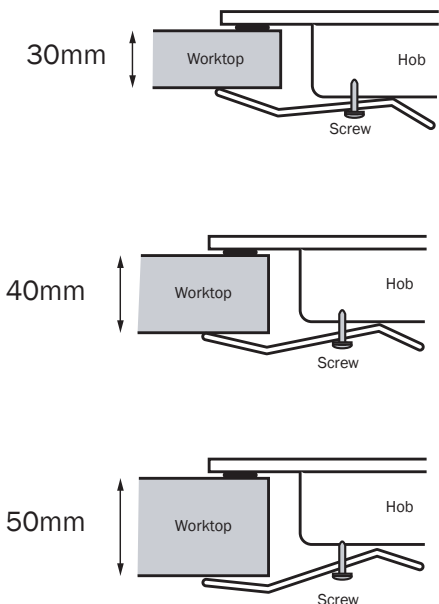

**Installation above an oven**

If the appliance is installed with an oven underneath, please leave at least 25mm of ventilation, unless otherwise stated in your oven installation guidelines.

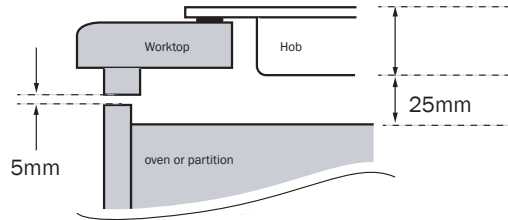

**Connect to the electricity Supply**



This appliance must be earthed.

The hob must be installed by a competent electrician, using a suitable double pole control unit, with 3mm minimum contact separation at all poles.

Connection should be made with a suitable cable.



Ensure that you route all mains electrical cables well away from any adjacent heat source, such as the base of the hob or oven / grill surface.

Strip the wires & connect to the terminal block as appropriate:-

- L = Brown/Red**
- N = Blue/Black**
- Earth = Green/Yellow.**

Fit the cable clamp & secure with the screw provided.

Close the terminal box, ensuring that the cover is closed and all screws in place.

## Technical Data

Outer Dimentions	
Width	580mm
Depth	510mm
Height	58mm
Cutout Dimentions	
Width	560mm
Depth	490mm
Cook Zones	
Rear Left Zone (Rapid)	□145mm 1500w
Rear Right Zone (Standard)	□180mm 1500w
Front Left Zone (Rapid)	□180mm 2000w
Front Right Zone (Rapid)	□145mm 1500w
Supply Information	
Total Electric Power	6500W
Supply Voltage	220-240V~50Hz
Fuse Protection	32 A min
Cable Type	HORR-F5 4.0mm □3 core or equivalent

This appliance conforms to European Directive 2009/125/EC regarding Eco design requirements for energy-related products

## 06 - Your guarantee

### Product Guarantee Details (UK only)

---

**Your appliance has the benefit of a comprehensive manufacturer's guarantee which covers the cost of breakdown repairs. (Details of which are shown on your Proof of Purchase Document).**

- Any claim during the period of the guarantee (MUST BE ACCOMPANIED BY THE PROOF OF PURCHASE)
- The product must be correctly installed and operated in accordance with the manufacturer's instructions and used for normal domestic purposes.
- This guarantee does not cover accidental damage, misuse or alterations which are likely to affect the product.
- The guarantee is invalid if the product is tampered with, or repaired by any unauthorised person.

**(The guarantee in no way affects your statutory or legal rights)**

**What to do if you need to report a problem-**

**Please ensure you have ready:**

- **The product's model & serial numbers**
- **Howdens Proof of Purchase document**
- **Your full contact details**



**Call the Service Line on 0845 00 60 006**

## Product Information

Commission Regulation (EU) No 66/2014

# LAMONA

Model	LAM1210/1/3
Type of hob	4 Burner Electric
No of cooking zones	4
Heating technology	Solid Hot Plate
Ø	FL- 180mm RL-145mm FR - 145mm RR - 180mm
EC <sub>electric cooking</sub>	FL- 206,07 Wh/kg RL-205,44 Wh/kg FR -205,44 Wh/kg RR -209,53 Wh/kg
EC <sub>electric hob</sub>	206,62 Wh/kg









If supplied, please stick your self adhesive product rating plate here, or make a note of the product serial number below in the box below for future reference.

Serial Number : .....

d



**HOWDENS**

JOINERY CO.

MAKING SPACE MORE VALUABLE



This brochure is printed on FSC certified paper

---